

CONSTRUCTION MATERIALS		
SHELL	TUBES	END COVERS
CARBON STEEL*	COPPER*	CAST IRON*
STAINLESS STEEL	STAINLESS STEEL	STAINLESS STEEL

- Dimensions and technical characteristics are not binding

*standard

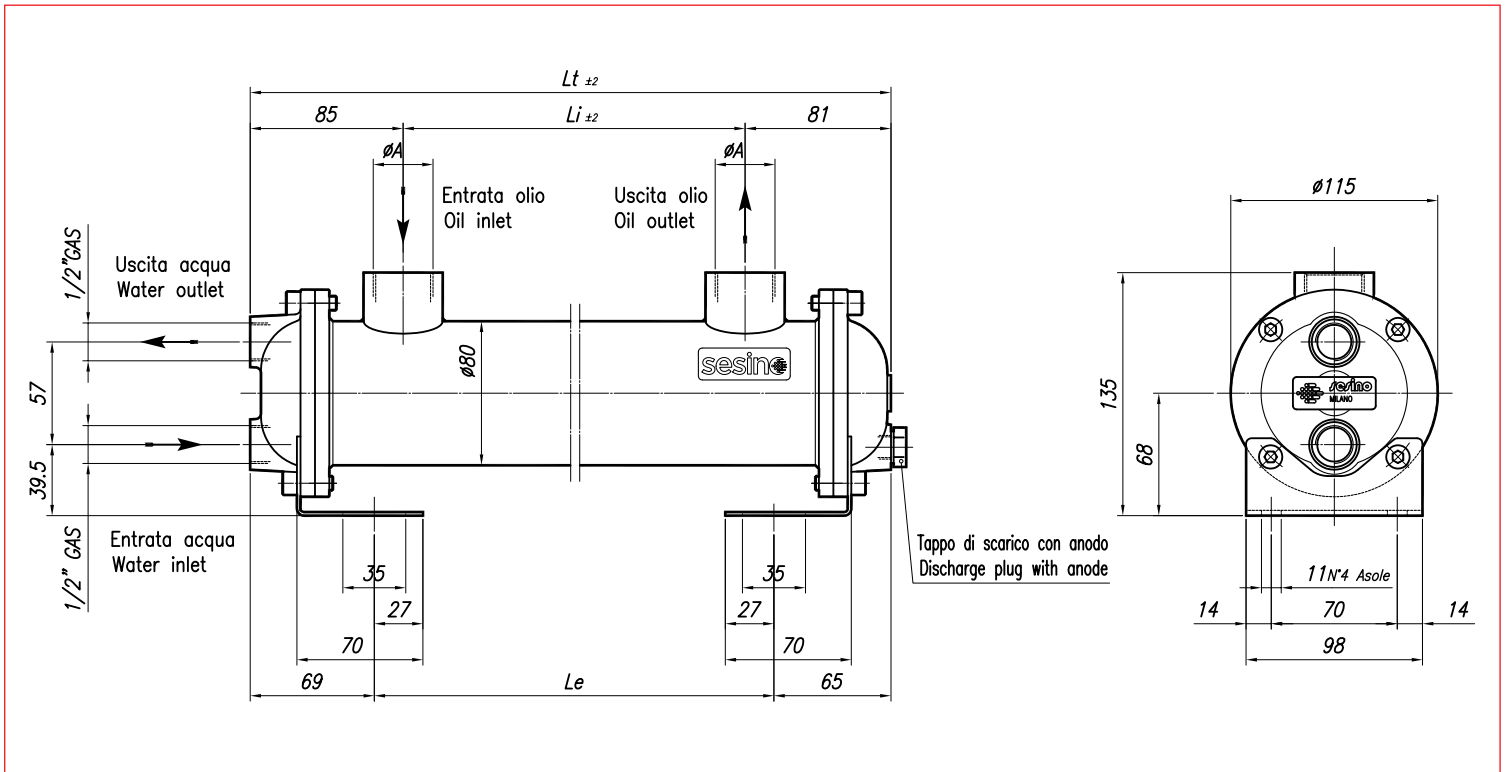

TYPE	CODE	WATER FLOW l/min	OIL FLOW l/min	kW MIN water flow		kW MAX water flow		WEIGHT kg	DIMENSIONS			
				ΔT_m 25° C	ΔT_m 25° C	ΔT_m 25° C	ΔT_m 25° C		F	Li	Le	Lt
MS 84 P1	2SC84P1	7,5 - 30	30-80	2	3	2,6	4,2	4,5	1" gas	150	150	308
MS 84 P2	2SC84P2	7,5 - 30	20-60	2,6	4	3,25	5,6	6,3	1" gas	310	310	468
MS 84 P3	2SC84P3	7,5 - 30	50-100	3,6	4,4	4,6	8	6,5	1 1/2" gas	310	325	478
MS 84 P4	2SC84P4	7,5 - 30	30-80	4,8	7	6	10	9,0	1" gas	560	560	718
MS 84 P5	2SC84P5	7,5 - 30	80-130	6	7	7	9	9,0	1 1/2" gas	560	575	728
MS 84 P6	2SC84P6	7,5 - 30	40-90	9	12	12	18	10,8	1 1/2" gas	715	730	883
MS 84 P7	2SC84P7	7,5 - 30	100-160	11	14	15	21	10,8	1 1/2" gas	715	730	883
MS 84 P8	2SC84P8	7,5 - 30	60-110	12	16	16	24	12,3	1 1/2" gas	870	885	1038
MS 84 P9	2SC84P9	7,5 - 30	140-190	15	17	21	27	12,3	1 1/2" gas	870	885	1038



WATER FLOW RATE:

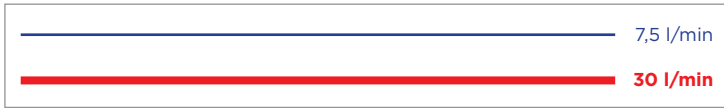

P1 P2 P3

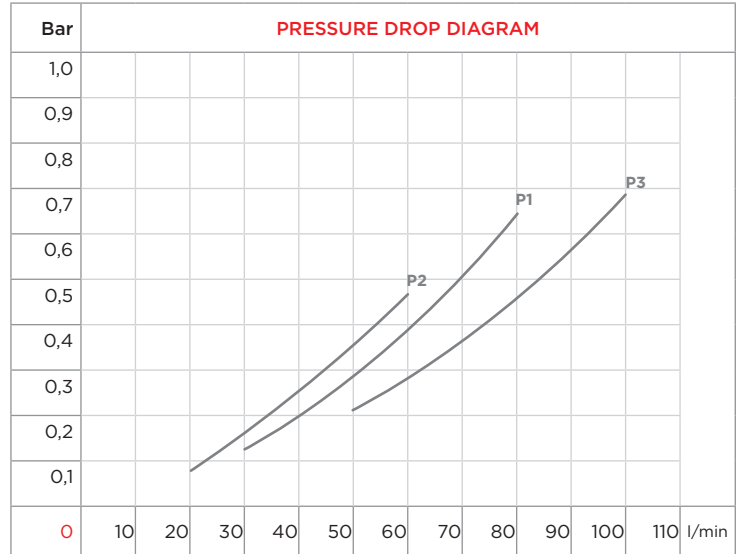
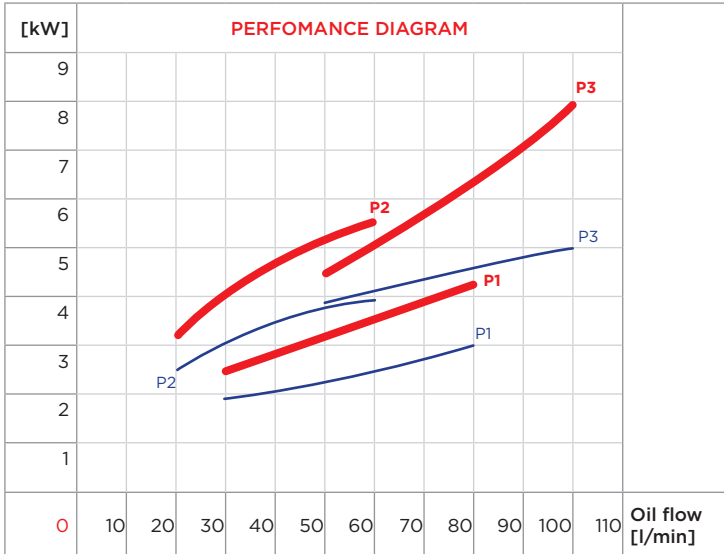

P4 P5 P6

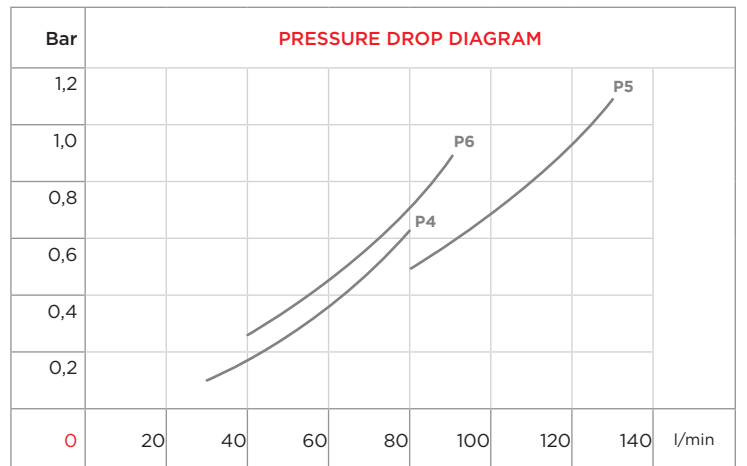
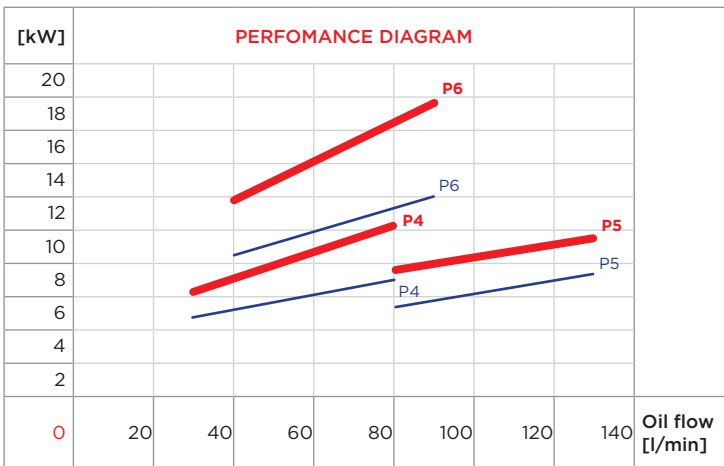

P7 P8 P9

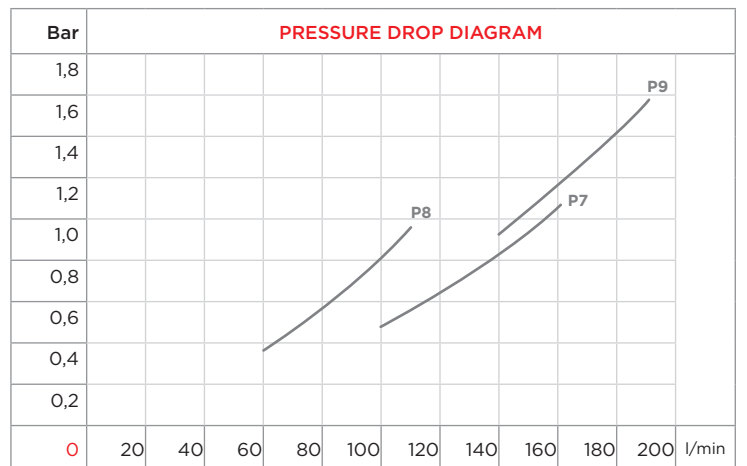
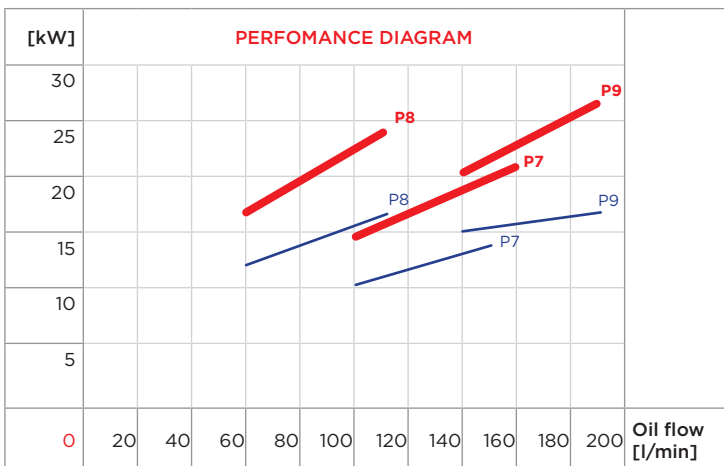

CORRECTION FACTOR							
ΔT_m	10	15	20	25	30	35	40
f	2,5	1,67	1,25	1	0,83	0,71	0,63

CORRECTION FACTOR							
cSt	22	30	46	68	100	150	220
f	0,4	0,6	1	1,5	2,3	3,3	4,6

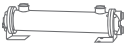

CONSTRUCTION MATERIALS		
SHELL	TUBES	END COVERS
CARBON STEEL*	COPPER*	CAST IRON*
STAINLESS STEEL	STAINLESS STEEL	STAINLESS STEEL
BRASS	CuNi (marine use)	BRONZE

- Dimensions and technical characteristics are not binding

*standard

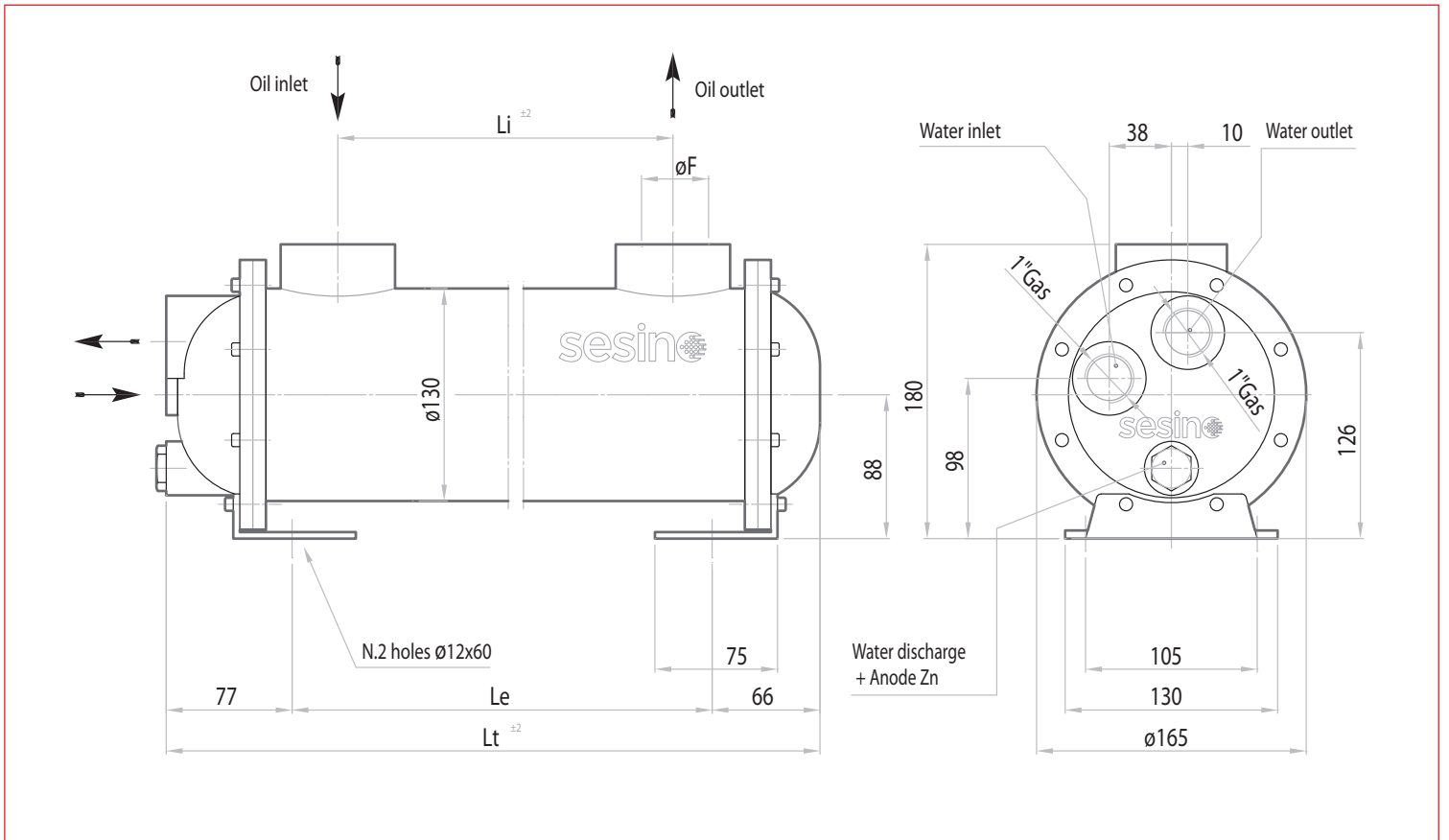

TYPE	CODE	OIL FLOW l/min	WATERFLOW l/min	kW MIN water flow		kW MAX water flow		WEIGHT kg	DIMENSIONS			
				ΔT_m 25° C		ΔT_m 25° C			F	Li	Le	Lt
MS 134 P1	2SC134P1	30-100	15-60	4	9	4	12	16,4	1 1/2" gas	285	286-384	480
MS 134 P2	2SC134P2	40-130	15-60	13	22	17	33	22,6	1 1/2" gas	535	536-634	730
MS 134 P3	2SC134P3	120-250	15-60	20	25	29	39	23,0	2" gas	520	536-634	730
MS 134 P4	2SC134P4	80-250	15-60	8,5	21	9	29	30,7	1 1/2" gas	845	846-944	1040
MS 134 P5	2SC134P5	200-400	15-60	31	39	48	70	30,9	2" gas	830	846-944	1040
MS 134 P6	2SC134P6	30-170	15-60	11	26	12	36	40,0	1 1/2" gas	1145	1146-1244	1340
MS 134 P7	2SC134P7	200-500	15-60	32	64	41	95	39,5	2" gas	1130	1146-1244	1340

MS 134 P



WATER FLOW RATE:

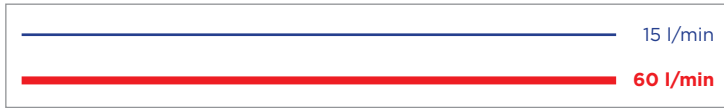

P1 P2 P3

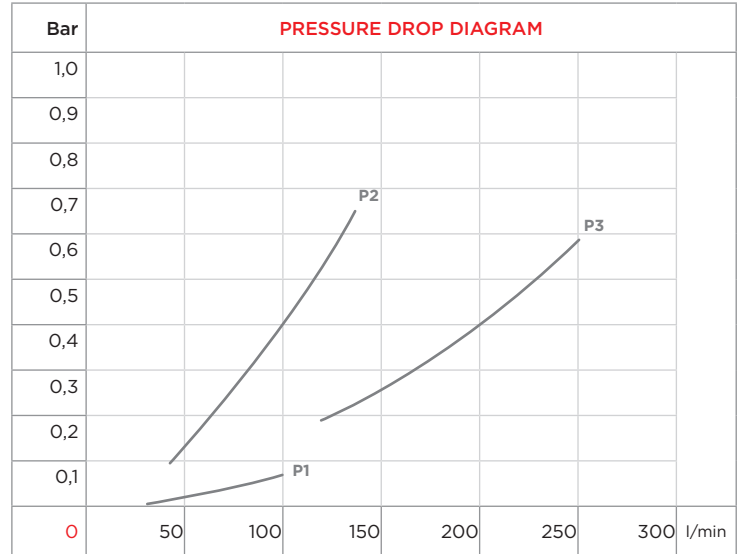
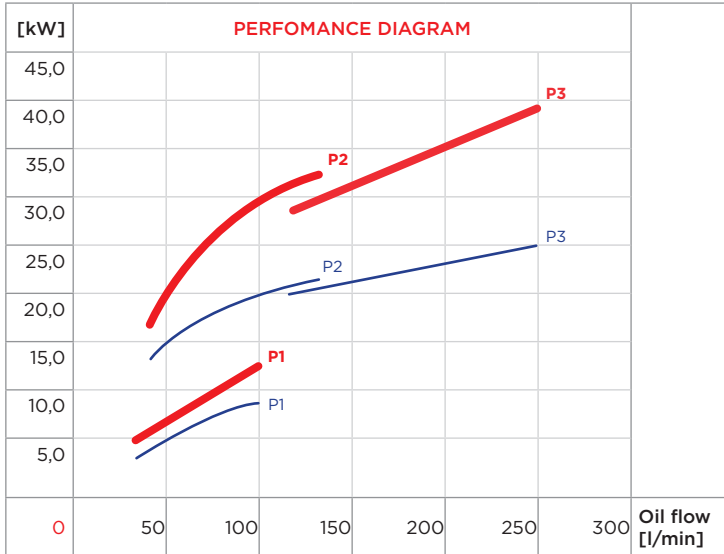

P4 P5 P6

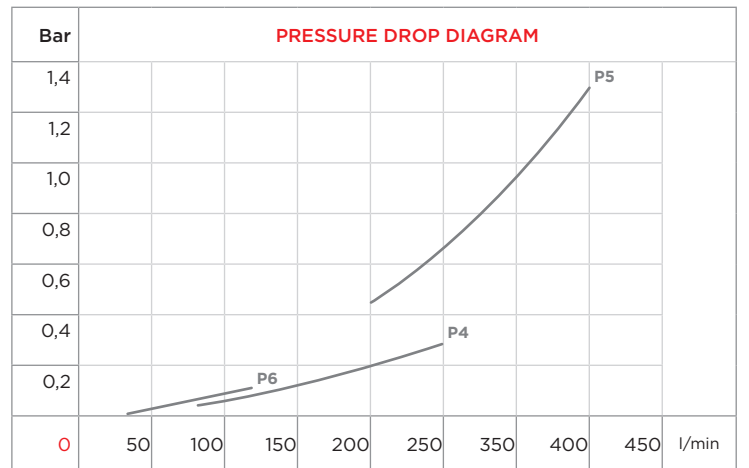
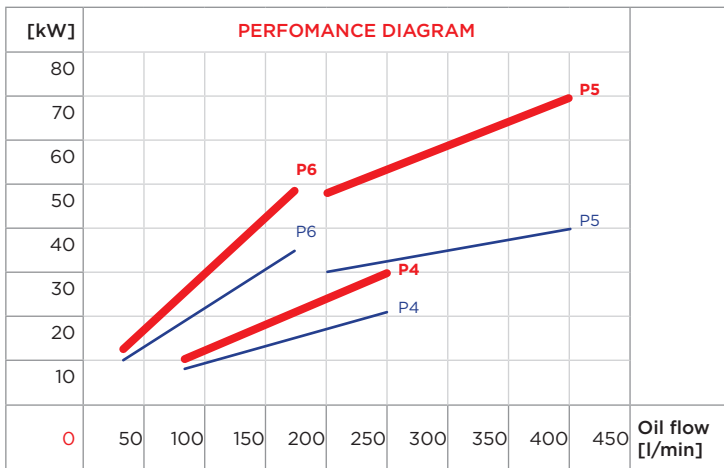

P7

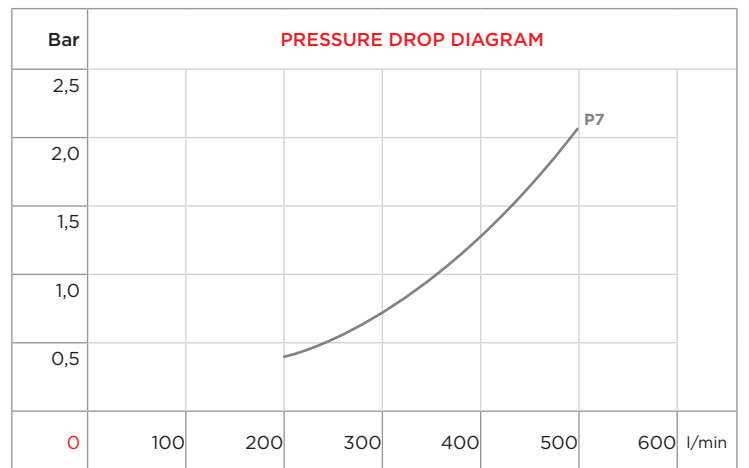

ΔT_m	10	15	20	25	30	35	40
f	2,5	1,67	1,25	1	0,83	0,71	0,63

cSt	22	30	46	68	100	150	220
f	0,4	0,6	1	1,5	2,3	3,3	4,6